

This symbol is intended to alert the user to the presence of uninsulated "dangerous voltage" within the product's enclosure that may be of sufficient magnitude to constitute a risk of electric shock to persons.



This symbol is intended to alert the user to the presence of important operating and maintenance (servicing) instructions in the literature accompanying the instructions.

LIMITED WARRANTY

Your Carvin product is guaranteed against failure for 1 YEAR unless otherwise stated. Carvin will service and supply all parts at no charge to the customer providing the unit is under warranty. Shipping costs are the responsibility of the customer. CARVIN DOES NOT PAY FOR PARTS OR SERVICING OTHER THAN OUR OWN. A COPY OF THE ORIGINAL INVOICE IS REQUIRED TO VERIFY YOUR WARRANTY. Carvin assumes no responsibility for horn drivers or speakers damaged by this unit. This warranty does not cover, and no liability is assumed, for damage due to: natural disasters, accidents, abuse, loss of parts, lack of reasonable care, incorrect use, or failure to follow instructions. This warranty is in lieu of all other warranties, expressed or implied. No representative or person is authorized to represent or assume for Carvin any liability in connection with the sale or servicing of Carvin products. CARVIN SHALL NOT BE LIABLE FOR INCIDENTAL OR CONSEQUENTIAL DAMAGES.

When RETURNING merchandise to the factory, you may call for a return authorization number. Describe in writing each problem. If your unit is out of warranty, you will be charged the current FLAT RATE for parts and labor to bring your unit up to factory specifications.

MAINTAINING YOUR EQUIPMENT

Avoid spilling liquids or allowing any other foreign matter inside the unit. The panel of your unit can be wiped from time to time with a dry or slightly damp cloth in order to remove dust and bring back the new look. As with all pro gear, avoid prolonged use in caustic environments (salt air). When used in such an environment, be sure the mixer is adequately protected by a cover.

IMPORTANT! FOR YOUR PROTECTION, PLEASE READ THE FOLLOWING: WATER AND MOISTURE: Appliance should not be used near water (near a bathtub, washbowl, kitchen sink, laundry tub, in a wet basement, or near a swimming pool, etc.). Care should be taken so that objects do not fall and liquids are not spilled into the enclosure through openings.

POWER SOURCES: The appliance should be connected to a power supply only of the type described in the operating instructions or as marked on the appliance.

GROUNDING OR POLARIZATION: Precautions should be taken so that the grounding or polarization means of an appliance is not defeated.

POWER CORD PROTECTION: Power supply cords should be routed so that they are not likely to be walked on or pinched by items placed upon or against them, paying particular attention to cords at plugs, convenience receptacles, and the point where they exit from the appliance.

SERVICING: The user should not attempt to service the appliance beyond that described in the operating instructions. All other servicing should be referred to qualified service personnel.

FUSING: If your unit is equipped with a fuse receptacle, replace only with the same type fuse. Refer to replacement text on the unit for correct fuse type.

SAFETY INSTRUCTIONS (EUROPEAN)

The conductors in the AC power cord are colored in accordance with the following code.

GREEN & YELLOW—Earth BLUE—Neutral BROWN—Live



U.K. MAIN PLUG WARNING: Amolded main plug that has been cut off from the cord is unsafe. NEVER UNDER ANY CIRCUMSTANCES SHOULD YOU INSERT/DAMAGED OR CUT MAIN PLUG INTO A POWER SOCKET.

REFER SERVICING TO QUALIFIED SERVICE PERSONNEL!

REPLACEMENT PARTS LIST

Table with columns for REF, Carvin P/N, Description, and various part numbers and descriptions. Includes items like Channel PCB Rev, Resistor, Capacitor, Potentiometer, Diode, LED, and various cables and connectors.

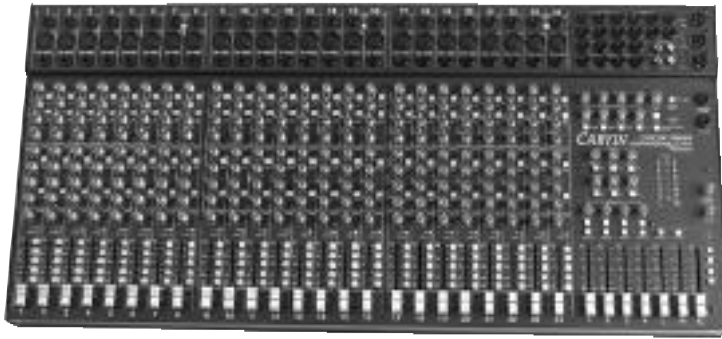

RECEIVING INSPECTION—read before getting started

INSPECT YOUR MIXER FOR ANY DAMAGE which may have occurred during shipping. If any damage is found, please notify the shipping company and CARVIN immediately. SAVE THE CARTON & ALL PACKING MATERIALS. In the event you have to re-ship your unit, always use the original carton and packing material. This will provide the best possible protection during shipment. CARVIN and the shipping company are not liable for any damage caused by improper packing. SAVE YOUR INVOICE. It will be required for warranty service if needed in the future. SHIPMENT SHORTAGE. If you find items missing, they may have been shipped separately. Please allow several days for the rest of your order to arrive before inquiring. RECORD THE SERIAL NUMBER on the enclosed warranty card or below on this manual for your records. Keep your portion of the card and return the portion with your name and comments to us.

Congratulations on the purchase of your mixer. Your new 4 buss Concert Series mixer demonstrates CARVIN's commitment to producing the highest quality and most sophisticated engineering in the audio industry today. The "C" series mixers are designed to be professional mixers for use in live performance sound reinforcement systems & studio applications. Features include a full function 4 buss console with stereo out, mono out, and grouped phantom power. The high quality construction will provide years of performance in and out of the studio. Enjoy your new mixer.

OVERVIEW

The MIC/LINE input channels feature Balanced XLR and TRS 1/4" inputs with grouped phantom power for condenser mics. There are 3 bands of EQ with MID SHIFT and LOW CUT switches, 2 pre or post fader AUX sends and 4 accessible post fader AUX sends on each channel. The master section features 4 sub Groups faders, 2 Master Stereo faders, a Center fader for mono. Also featured in the master section are the 6 AUX send Masters and 4 stereo returns.

CHANNEL EQ WITH ACTIVE TONE CIRCUITS

The Concert Series incorporates 3 bands of EQ per channel. They offer smooth non interactive tone curves so your adjustments will sound natural and yet be effective. The high (treble) and low (bass) "shelving" type controls cover the complete upper and bottom portions of the audio range. The LOWCUT switch provides instant elimination of unwanted low frequencies below 75 Hz. The MID EQ controls are a "band pass" type which peak at 2.5k Hz or 700 Hz (depending on the MIDSHIFT switch) for added presence to your mid range tones. Because CARVIN uses "active" tone circuits, you are able to boost or cut your tones without any signal loss to your sound.

INTERNAL SIGNAL ROUTING

A balanced mic or instrument plugs directly into the high quality Neutrik™ XLR connectors and is then routed into the differential circuits for excellent hum and noise cancellation. As your signal continues within the console, a double-sided FR-4 (fire rated) printed circuit board carefully guards the circuit traces with a copper shield running over the traces. This reduces RF interference and crosstalk substantially. The printed circuit board has plated-through holes which means every component is soldered securely in three places (on the bottom, in the hole and on top). This offers unsurpassed component security while reducing circuit resistance for pure dynamic sound.

HEADROOM

Headroom is very important when designing a mixer—especially for recording. Lack of headroom will cause your sound to become distorted and muddy. This can happen when you turn the volume too high, the input signal is too hot or excess EQ is added. With most mixers, you have to reduce the input gain to fight headroom problems, but this just increases noise. That's why we have taken great care in the "C" series to make sure that each gain stage is properly designed and balanced for more headroom along the entire audio path.

SWITCHING POWER SUPPLY

The Concert Series power supply offers unsurpassed rejection of noise and hum while providing precision voltage for all preamp stages. The internal switching power supply takes the 60 Hz AC line input and immediately converts it to 100kHz well outside of the audio range. The 100kHz AC is sent through a transformer and converted to precision DC voltages. Now you can go anywhere and never worry about inconsistent sound due to fluctuating voltages because your mixer automatically switches internally to use 120 or 240VAC. (120VAC & 240VAC compatible with the proper AC cable) CARVIN has spared no expense to achieve the best possible quality & performance.

For your records, you may wish to record the following information.

Serial No. _____ Invoice Date _____

C2440 BLOCK DIAGRAM

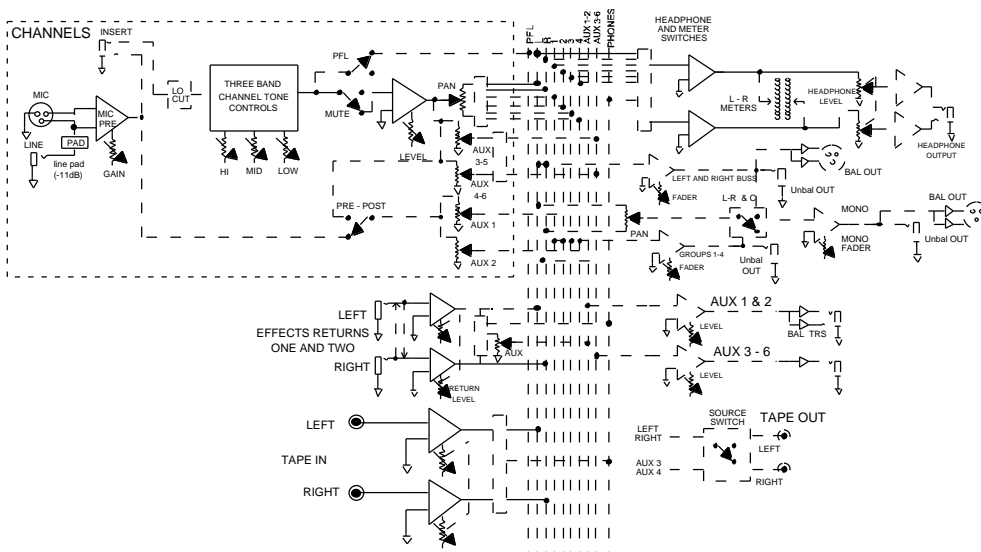

C2440 SPECIFICATIONS:

Frequency Response:	Mic or Line Inputs: 20Hz-20KHz ±1dB
Total Harmonic Distortion:	Less than .01%
Equivalent Input Noise:	150 ohm source: -112dBu
Output Noise:	less than -90dBu Master Line Out (all levels minimum)
Output Headroom:	+28dB XLR bal, +20dB 1/4" unbal
Maximum Gain:	Mic in to Master Line Out: 74dB
Crosstalk:	Adjacent ch's: -60db at 1KHz
Common Mode Rejection:	-80db at 1KHz
Phantom Power:	All XLR Mic in (channel groups of 8)
Channel EQ.:	3 band active, LOW: 80Hz ±15dB
	MID: 2.5K or 700 Hz±15dB
	HI: 11.5KHz ±15dB
Mic Input:	Balanced XLR input
Line Input:	Balanced 1/4" Phone Jack
Power Consumption:	40VA
Size:	14"D x 30"W x 3.1"H



12340 World Trade Drive, San Diego, CA 92128
(619) 487-1600 (800) 854-2235
www.carvin.com

QUICK START UP

If you're like most new owners, you're probably in a hurry to plug your mixer in and use it. Here are some brief instructions to get you going quickly. With the mixer unplugged and the unit turned off, complete the following procedures:

1. CONNECTING AC POWER TO YOUR MIXER

- The mixer can be used with 120 or 230VAC (it automatically switches internally)
- Use only a grounded (3 prong) outlet to prevent a shock hazard. This gives the quietest grounding for your mixer.

2. CONNECTING INPUTS TO YOUR MIXER

- For low level balanced devices such as microphones, plug into the balanced **MIC** inputs using a shielded microphone cable with XLR ends.

- For high level balanced or unbalanced devices such as instruments & Keyboards, plug into the **LINE** input jacks using a shielded cable with 1/4" Stereo or standard phone plugs. Adjust the **GAIN** knob for the mic or line input being used.

3. TURNING YOUR MIXER ON

- Adjust all channel **FADERS** and master **LEVEL** controls to their **OFF** positions
- Adjust all channel **HI**, **MID**, and **BASS** controls center.
- Adjust all the Channel "**PAN**" controls to their center position.
- Turn the mixer on by the rear panel **POWER SWITCH** and watch for the **POWER LED** to come on. Your mixer is now ready to operate.

become **AUX 5** (the control labeled **3-5**) and **AUX 6** (the control labeled **4-6**). This feature gives you a total of 4 auxiliary mixes and reduces the number of controls that need to be adjusted.

10. STEREO PANNING

Each channel's **PAN** control allows sweeping stereo effects when panning from L to R for recordings or live sound. Superior channel separation is available because of the "dual element" pan controls providing 15dB greater Left & Right separation over standard mixers. A true stereo image can be obtained from any of the output connections marked **L & R**.

11. CHANNEL SIGNAL GREEN LED

The signal indicator is pre-fader and post EQ. This LED verifies that the channel is receiving a signal from the mic or instrument inputs.

C2440 CONTROLS

CHANNEL FEATURES

1. 1/4" LINE IN

The line connectors are for connecting balanced and unbalanced instruments, mics and line level sources such as drum machines or keyboards.

2. XLR MIC IN

The balanced Mic inputs are for connecting pro microphones that use XLR connections.

3. CHANNEL INSERT/CHANNEL DIRECT

To insert a channel effect use a 1/4" TRS (Tip Ring Sleeve) instrument cable and fully insert it into the jack. Connect the other end of the cable to the effect's output. To use as a direct output for multi-track recording use a 1/4" instrument cable and insert to the first "click" (1/2 insert). Connect the other end of the cable to an input on a multi-track recorder.

4. GAIN CONTROL

Adjusts the **GAIN** when connecting various instruments & mics. The type of mic (uni-directional, omnidirectional, etc) and model will require a custom **GAIN** settings for each individual mic. Monitor the **GAIN** level with the **PEAK LED**. If an LED is constantly illuminated, decrease the amount of **GAIN**. If distortion is present, decrease the amount of **GAIN** until the distortion is eliminated.

5. LOW CUT SWITCH

75 Hz low cut filter helps eliminate unwanted low frequencies. Great for reducing "boom" noise from mic stands or from hollow body acoustic/electric guitars. This filter can also help "punch up" the bass by turning up the **LOW** tone control while using the **LOW CUT** switch.

6. MID SHIFT SWITCH

The **MID SHIFT** is an exclusive feature giving you a choice of two different midrange center frequencies. This is ideal for vocals and/or instruments. The **MID SHIFT** is easier to use than conventional sweep controls because it allows you to compare for the best vocal or instrument sound by switching between the two MID frequencies.(2.5k Hz or 700 Hz)

7. ACTIVE 3 BAND CHANNEL EQ

This 4 buss mixer provides studio quality tone controls with distortion less than .01%—*exceptionally clean for recording & live sound!* The ±15 dB boost and cut gives an overall 30 dB range of powerful EQ control. The active circuits deliver deep bass from the 20-80 Hz **LOW** control. The **MID** control works in the 2.5k Hz range or the 700 Hz range depending on the **MID SHIFT** switch. The **HI** control functions at 11-20k for crisper highs. Start out with all three controls at their center zero position. Determine which position your **MID SHIFT** sounds best at, then cut or boost your **HI**, **MID** and **LOW** frequencies as needed. If you are trying to mic instruments such as acoustic guitar or drums, try various mics and mic placement before adjusting your tone controls (condenser mics work well for these applications). Cutting and boosting frequencies improper

ly can cause an "un-natural" sound to your vocals or instruments. Your goal is to achieve a natural sound for the entire performance or recording.

8. CHANNEL AUX 1-2, PRE-POST

AUX 1 & 2 can be used as 2 individual monitor mixes. Adjust the monitor level from each channel with the **AUX 1 & 2** controls. The **PRE-POST** switch should be set to **PRE** (pre-channel EQ and pre-fader) when using AUX 1 & 2 as monitor mixes. The **PRE-POST** switch should be set to **POST** (post-channel EQ and post-fader) if AUX 1 & 2 is to be used for effects sends.

9. CHANNEL AUX 3-4, 5-6

Here are 4 more AUX controls paired up. With the **5-6** switch OUT the two AUX controls become **AUX 3** (the control labeled **3-5**) and **AUX 4** (the control labeled **4-6**). When the **5-6** switch is in the IN position, the AUX controls then

12. CHANNEL PEAK RED LED

This peak indicator is pre-fader and post EQ. A constantly lit LED indicates the signal probably needs a reduction in **GAIN** to prevent input overloading.

13. CHANNEL MUTE SWITCH

Mute a channel instantly without touching your faders. This is extremely useful when you need to mute channels but can't afford to lose fader settings.

14. CHANNEL PFL SWITCH

This switch allows the operator to monitor each channel to set tone, gain and effect levels before turning up the fader

15. CHANNEL ASSIGNMENT SWITCHES

These switches assign the channels' signal to the group faders for each mixing end to the left & Right faders in the

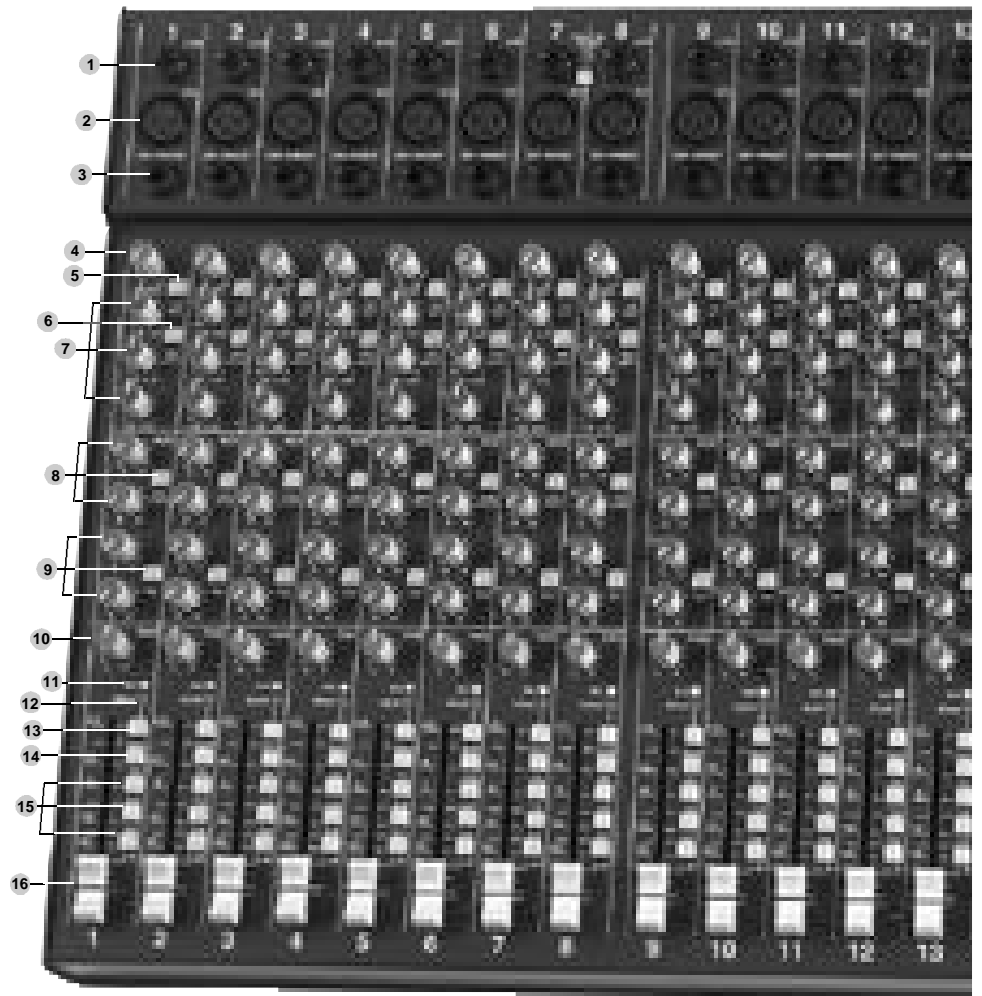

Master Section. Each channel can be assigned to the 1-2, 3-4, and L-R Faders in stereo pairs. This feature allows the operator to group certain channels (such as the channels used to mic an entire drum kit) and assign them to one pair of the master faders in the 1-2, 3-4 sub group. This sub-mixing feature decreases the number of channel faders that need to be adjusted.

16. AUDIO TAPER FADERS

Slide all faders down when connecting your inputs. Increase each channels fader to achieve the overall mix. Calibrated 60mm faders with audio taper are featured for smooth fade-outs.

MASTER SECTION

17. GROUPS 1 - 4

Once a channel has been assigned to one of the 4 groups (see 15), 60mm faders control the level of each group.

channel is great for a third main mix, a subwoofer out or in the case of a main mono mix, group 1-4 and L-R creates a 6 buss console.

20. CONTROL ROOM SELECTION SWITCHES

Use these switches to select what is heard through the headphones and control room jacks. Select LEFT-RIGHT, CENTER, GROUP 1-2 or GROUP 3-4

21. PFL RED LED

Indicates that the headphone, control room, and meters are monitoring the channels where the **PFL** is switched on.

22. L-R SUB TO CENTER SWITCHES

Assigns the **LEFT-RIGHT** mix to the **CENTER** Fader.

23. PHONES CONTROL

The **PHONES** control sets the desired level of the **PHONES** jack for monitoring through headphones.

28. POWER LED Verifies the mixer is on.

29. PHONES JACK

1/4" stereo jack for headphone or control room output.

30. TAPE IN TO L-R SWITCH

This switch assigns the source coming from the **RCA TAPE IN** connections to the L-R mix.

31. TAPE IN CONTROL

This adjusts the level of the source coming from **TAPE IN**.

32. CONTROL ROOM JACK

This 1/4" stereo connection is for headphones or connecting a control room power amp & studio reference monitors.

33. TAPE OUT SOURCE

This switch changes the tape out source from **L-R** to **AUX 3-4**. This is a great feature for 2 track live recording where a different mix is needed from the L-R house mix

34. STEREO RETURNS

Each return contains a master level for the **L-R** mix and a master level for the **AUX** (monitor mix) with **RETURN 1 & 2** going to **AUX 1**, and **3 & 4** going to **AUX 2**.

35. TAPE IN-OUT

Stereo RCA jacks for connecting a tape recorder or CD player.

36. CENTER

XLR balanced output from the **CENTER** fader.

37. LEFT / RIGHT XLR & 1/4" CONNECTORS

This set of balanced and unbalanced connectors are for connecting the main mix to external power amp(s).

38. 1/4" GROUP OUTPUT CONNECTORS

1 through 4 offer output of each individual **GROUP** fader for use in multitrack recording or connecting additional power amps for stage monitors or main house speakers.

39. AUX SENDS

Six 1/4" output connectors drive external effects. Or, use these sends to drive additional power amps for stage monitors. The **C2440** provides balanced 1/4" outputs for long cable runs on **AUX SENDS 1 & 2**.

40. AUX RETURNS

Four 1/4" stereo pairs (8 inputs) to return external effects in stereo.

42. MIC PHANTOM POWER SWITCH / RED LED

This switch provides phantom power for condenser mics in groups of 8 channels. This allows other channel groups

to remain non-powered to use the **LINE** inputs for instruments and **MIC** inputs for mics that don't require phantom power. The groups reduces noise and wasted power.

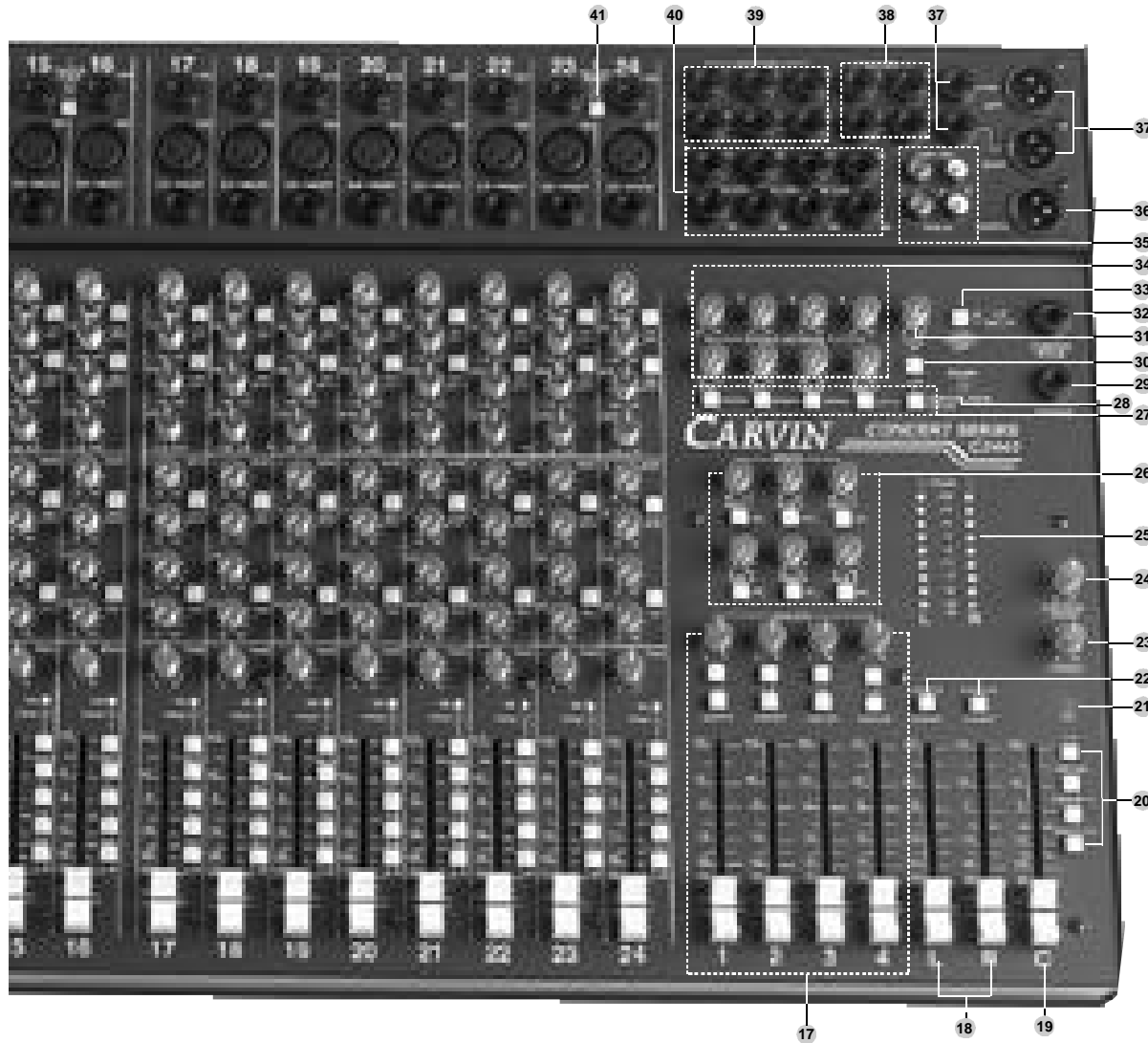

The 4 output connections (see 38) are the output of these 4 faders. By assigning the 4 faders to the L & R faders and/or the Center fader the operator can use the 4 groups as sub-mixes. Each fader has assignment switches and a sub-mix pan control for L-R assignments.

18. MASTER LEFT & RIGHT FADERS

These faders send the main stereo mix from all channels and **GROUPS** assigned to the L-R Faders. This mix is then routed to the main balanced and unbalanced output connectors (see 37). The left and right signals will be identical if all pan controls are set to their center positions.

19. CENTER FADER

The Center fader gets its signal only from the center assignment switches on the 4 groups and L-R. The Center

24. CONTROL ROOM

The **CONTROL ROOM** knob adjusts the level of **CONTROL ROOM** output jack for monitoring.

25. L-R LED VU METERS

This group of LEDs are ten segment 6 dB resolution meters that give the operator the mixer output from 30mv to 15.8vac.

26. AUX SENDS

These are the Master Sends for AUX 1-6. Each has its own PFL switch to assist in adjusting the send level.

27. CONTROL ROOM LISTEN

These 5 switches function just like the Control Room Selection Switches (see 20) providing a stereo listen for the 4 returns and Tape In.

STEREO LIVE SOUND SYSTEM

In a live sound reinforcement or a public address system (P.A. System), the input signals to the mixer will come from the microphones and instruments on the stage. Each microphone or instrument to be amplified by the P.A. system must be connected to one of the mixing console inputs. It is preferred to have as many of the stage instruments as possible plugged into the mixer. This allows for the best overall sound control of the instruments as they are mixed together and then amplified by the P.A. system. The mixer can be operated on the stage or from a remote location in front of the stage using a snake cable to bring the signals from the stage to the mixer. The advantage of the remote operation allows the performance to be monitored and mixed from the audience's perspective.

THE SOUND CHECK

The sound check takes some skill, but mostly patience from the performers and especially you the system operator. If you get frustrated during the sound check, the performers can lose confidence and the sound may suffer due to things missed in the sound check. The basic sound check follows this format: First test all microphones and other input devices (direct boxes, etc.) before the performers are includ-

ed in the sound check. A good thing to also check here is feedback in the monitors from the microphone. Good positioning of the monitors and the use of a graphic equalizer solves most major monitor feedback problems. Now for a sound check with the performers. First set the level of each performer individually and in cases where a performer has multiple microphones, such as with drummers, set each drum mic individually then the drum set as a whole. This is also a good time to make some channel tone control adjustments to tailor the sound of the individual performers and instruments. After setting each individual, have the performers run through a song. Don't hesitate to stop the performers if something needs to be adjusted or a performer or microphone needs to be heard solo again. Remember the sound check is not a rehearsal, but a system check. It is always a good idea for the mixer operator to have a microphone to inform the performers of what is needed during the sound check. If a monitor system is being used, the mixer operator's microphone should only be heard through the monitors when addressing the on stage performers, especially if something needs to be checked during the show. If the sound check is allowed to run through its full course, the system should run smoothly at show time.

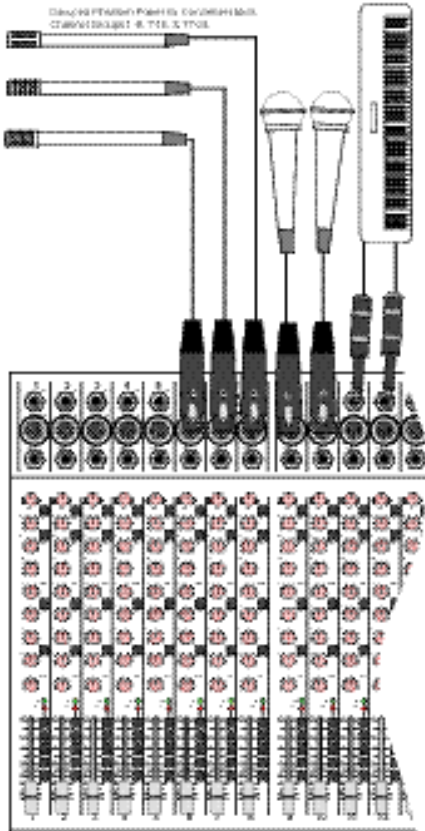

CHANNEL CONNECTIONS AND SUB-MIXING

The 24 XLR Mic inputs are balanced low impedance inputs. Channels 1 through 8, 9 through 16 and 17 through 24, each have their own phantom power switch. This enables the user to group all Mics that require phantom power together, leaving the rest of the channels available for dynamic microphones or XLR line inputs. The grouping of the phantom power reduces noise, power, and the risk of damage to unprotected XLR inputs. The XLR Mic inputs and 1/4" Line inputs on each channel can be used simultaneously, however the two signals will be controlled by the single Gain knob. For this dual input use, the levels will have to be balanced by adjusting the level of the instruments connected at the Line input. For stereo instruments, such as keyboards or drum machines, use two consecutive channels to connect the Left and Right outputs from the instrument. Then by adjusting the Pan controls on the two channels, the stereo image can be retained. If a pair of individual channels are not available, one of the stereo returns can be used.

Whenever possible, try to group all related instruments or mics near each other on the mixer. For example: put all drum mics on channels 1 through 8, guitars, bass and keyboards on 9 through 16, and vocals on 17 through 24. This will make mixing, channel assigning and sub-mixing easier to manage. When a long distance separates the sound source from the mixer, a mic snake cable system will be required. Be sure to get a snake that has more than enough Mic connections and returns as you may need to use them in the future. (ask about Carvin's SNK24XR cable systems)

The 4 Groups on the C2440 can be used for main outputs, surround outputs, side fills, outputs to a multi-track recorder, etc., but the most common use is for sub mixing to the main L-R or in a mono out cast to the Center Fader. Sub-mixing is used in cases where there are a group of channels controlling microphones from a common instrument or a group of musician working in unison, for example: a drummer with 4 or more microphones, or a choir with several microphones, needs a simple level adjustment. In each of these examples the individual microphones all use different fader settings, so during the sound check or show if the drummer, with 6 microphones individually set to a good drum set sound, needs to be turned up, all 6 microphones would have to be turned up individually paying close attention to the original relative settings of the faders to each other. With sub-mixing, this all becomes a simple one or two fader movement during the show leaving intact the original drum set mix. With sub mixing, the same 6 microphones are individually set for the overall drum set sound. Then the drum channels are assigned to one of the group pairs, 1-2 or 3-4, and unassigned from the L-R mains. If the drums are to be mixed mono, then the pan control can be further used to assign to the individual groups. After each channel is assigned, then the group is assigned to the L-R or Center as the case maybe for the main mix. Now during the show if the drummer or other group level needs to be adjusted, the assigned Group fader can be used.

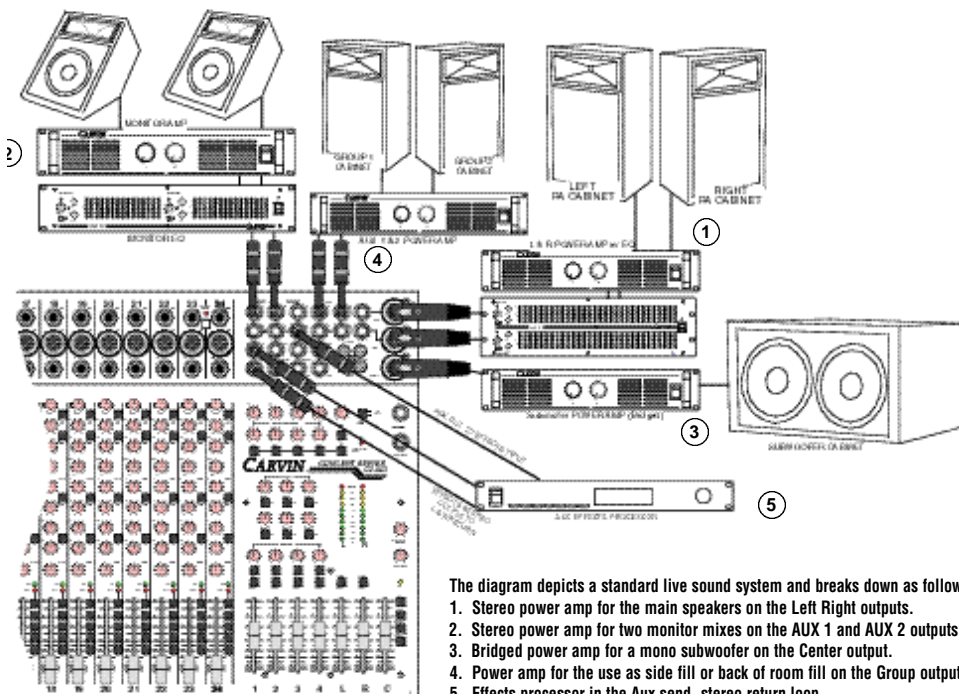

The diagram depicts a standard live sound system and breaks down as follows:
 1. Stereo power amp for the main speakers on the Left Right outputs.
 2. Stereo power amp for two monitor mixes on the AUX 1 and AUX 2 outputs.
 3. Bridged power amp for a mono subwoofer on the Center output.
 4. Power amp for the use as side fill or back of room fill on the Group outputs.
 5. Effects processor in the Aux send, stereo return loop.

MASTER OUTPUTS

The main stereo loudspeakers should contain an overall mix of a channels. The Group faders 1-4 can have certain channels assigned to them before the mix arrives at the master L-R faders. This is known as sub-mixing and can improve the efficiency of mixing a large number of channels (see above).

The two independent monitor mixes should use the AUX 1 and AUX 2 sends. On the channel these AUX's are pre-EQ, pre-fade with the pre/post switch up position allowing the channel EQ and fader to be used for the main mixes. Also AUX 1 & 2 1/4" output jacks are balance for long mixer to stage cable runs.

The Center output can be used for a main mono mix, a center mono mix in a surround sound type of application, or as a mono subwoofer output.

The Group outputs can be used as side fill monitors on stage, or as back fill for the audience. Back fill for the audience is used to fill in areas of a room that may be lacking sound from the main mix. Long rooms can have poor sound at the back of the room, setting up a set of loudspeakers in the back to fill in that area can improve the sound of the room. Without using the group faders to sub-mix assign channels such as vocals & instruments to groups 1-2 to help eliminate "muddy" or "delayed" sounds at the back of the room. Be careful not to overpower the main mix or the people at the back of the room will only hear what you've assigned to that "fill in" group.

External effects should be used on AUX sends 3 through 6, leaving AUX's 1 and 2 for monitors. The purpose for using AUX's 3-6 are their channel post-fader and EQ positions. This allows the automatic raising and lowering of the effects on a channel to correspond with the channel level in the mix. If the channel is turned off then the effect is also turned off.

INSERTS AND DIRECT OUTS

FULL INSERT

The insert jack is a Tip Ring Sleeve (TRS) 1/4" phone jack, where the tip is the send, the ring is the return and the sleeve is ground. When used as an insert point or in full insert mode, the channel is opened up to allow an external piece of equipment to be inserted into the channels signal path. The channel signal coming from the microphone preamplifier will be forced to go through the external equipment before it can continue back through the channel re-entering before the channel tone controls. Most external equipment is not set up for the TRS plug directly so an adapter cable is required. The adapter cable will have on one end the TRS plug and two mono plugs either male or female, on the other end. The two plugs each have the ground connected to the sleeve, one has the return on its tip and the other has the send on its tip. This allows the send to be connected to the input of the external equipment and the return to its output completing the insert loop back to the channel.

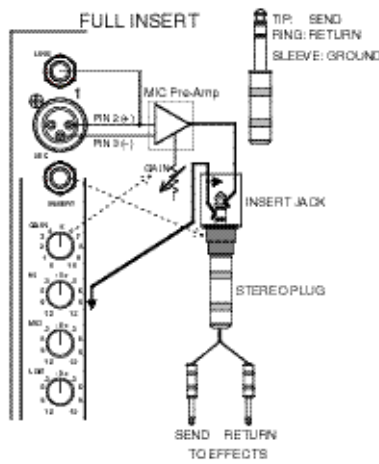

HALF INSERT DIRECT OUT

The half insert connection creates a send signal without breaking the channels signal path. The insert in this mode is no longer used as an insert but it becomes what is called an "insert direct out". An insert direct out functions as a normal direct out but the plug has to be half inserted. If an insert is needed on the same channel, special cabling is required to perform both functions. The half insertion connects the tip of the plug being inserted to the ring of the jack. See the fig. If the jack is fully inserted to where the tip of the plug connects to the tip of the jack, the internal jack switch will open and the channel's signal path will be broken. The connection will still function as a direct out but the channel's signal will stop at the insert and not continue on to the rest of the channel and the masters. The result of the half insert is multiple outputs for use in multi-track recording.

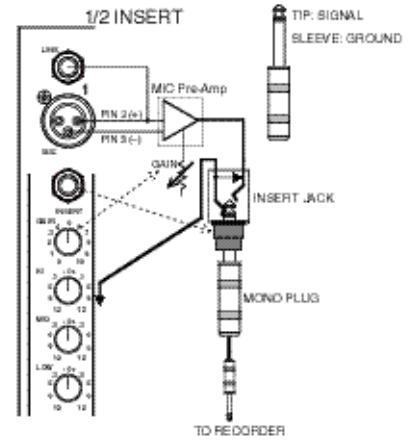

MULTI-TRACK RECORDING

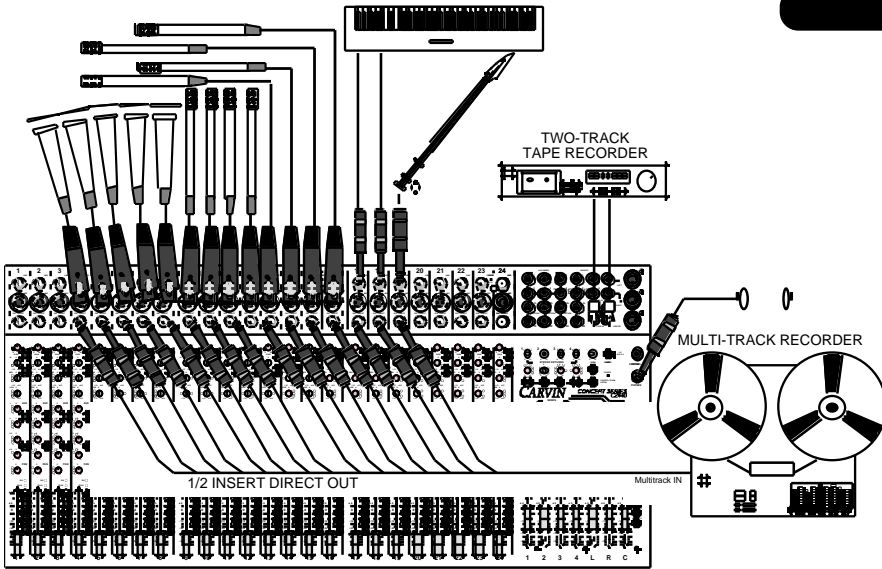

A multi-track recorder can be connected to the Channel Direct Out jacks. This set up could be used with a live set up to record a live show. Also shown in this illustration, is the connection of a 2 track tape recorder connected to the RCA tape outs. One of the great features of the C2440 is the Tape Out Source switch. By assigning AUX 3-4 to the Tape Out Source, the operator can create an alternate mix for 2 track recording and maintain an unaltered main mix.

If a 4 track recorder is used, assign the channels to the 4 group faders and use the group outputs for a 4 track recorder. For an 8 track recorder, parallel the 4 groups using group 1 for tracks 1 and 5, group 2 for 2 and 6, etc. Then use the 8 track recorder's track enable switches to select the track. Also both methods can be combined using the groups and Direct Outs for multi-tracking.

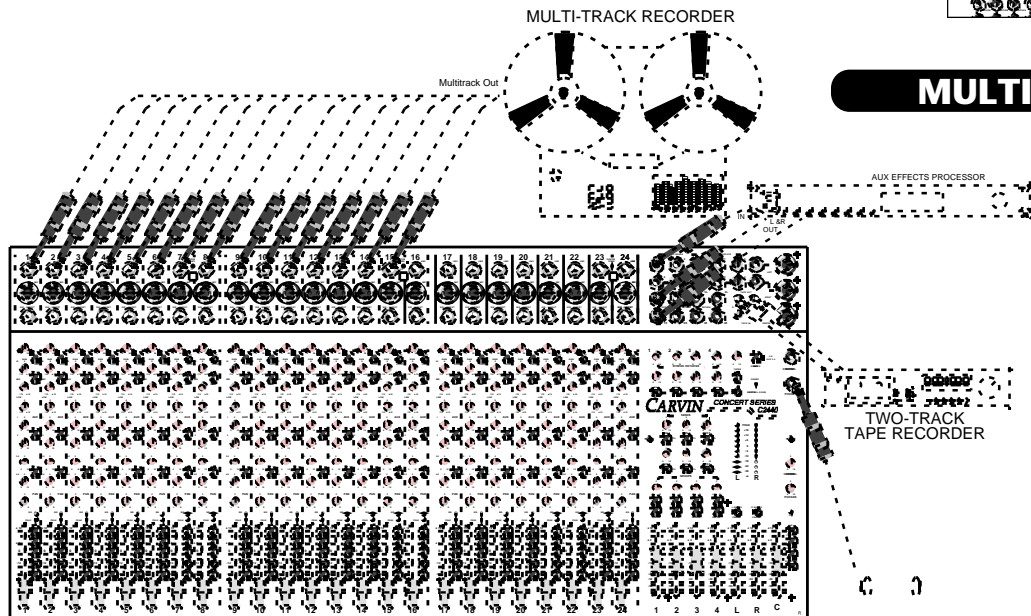
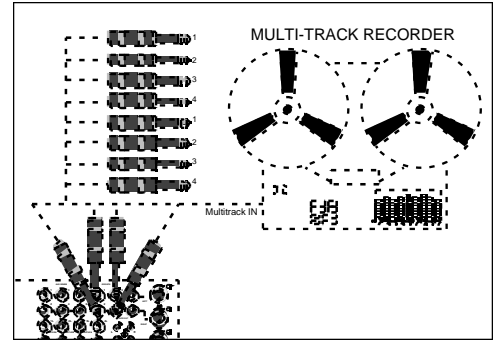

MULTI-TRACK MIXDOWN

Follow this set up for mixing down to a two track recorder. Connect the Multi-track recorders' outputs to the line inputs of the channels. Use the headphones or connect a professional power amplifier (Carvin's DCM power amps) and high quality studio monitors to your main LEFT & RIGHT outputs to monitor your mixdown sessions. Mixing is a practiced skill. A trained ear will know when to add EQ, effects, compression, gate, and when not to. Listen to your favorite CD through the same headphones or monitoring system you plan to mix through. Note each instrument's level and position in the stereo mix. Use this as a guide to help mix your project. Mixing down to a digital format such as DAT or to an analog reel to reel will yield different results. Digital recorders are meant to accurately represent the original sound source, therefore you should get exactly what you heard while mixing.